

JACK-LUBER™

MODELS 125cc and 250cc INSTALLATION INSTRUCTIONS

Working Principle

The **JACK-LUBER™** is a self-contained, microprocessor controlled, motor driven automatic lubricator. The **JACK-LUBER™** lubricator operates using a jack screw which pulls the piston down to the lubricant outlet. This dispenses the lubricant at a controlled rate at pressures up to 200psi. This pressure allows the **JACK-LUBER™** to be used with long feed line pipework.

When one or a combination of selector switches are turned on, the unit will activate at selected intervals (see charts on page 3). At each interval, approximately 0.5 grams of grease will be delivered to the bearing. The grease output is not affected by temperature or altitude. The **JACK-LUBER™** is available in **125cc or 250cc sizes** and can be filled with lubricant of your choice. When the unit is empty, simply change the replaceable lubricant reservoir and battery pack.

General Information

On every installation, using a hand grease gun and the same type of grease, pump a few shots of lubricant into the bearing. It is recommended and good practice to purge the bearing on every change out. If fittings or grease lines are used, these also should be filled with the same lubricant.

If possible, install the **JACK-LUBER™** directly on the bearing. All **JACK-LUBERS** have ½" NPT threads.

If the **JACK-LUBER™** is remotely mounted, the following applies:

- For tubing or pipe up to 20 feet in length, use minimum 3/8" O.D. by minimum 1/4" I.D.
- Oil filled units, use minimum 3/8" O.D. by minimum 1/4" I.D. tubing for up to 200 feet

It is important to make sure you prime all piping and lube points prior to installing the JACK-LUBER™.

For optimal performance, the **JACK-LUBER™** works best with multi-grade (synthetic) lubricants. High temperature lubricants, with an NLGI 2 or higher rating, tend to harden at low temperatures, therefore, lower NLGI ratings are recommended (NLGI 1). In low temperature applications use Lowtemp lubricants with NLGI 0 or 1 rating.

To ensure the success and reliability of your **JACK-LUBER™**, do not use in temperatures below -4° F or above 140°F (-20°C to 60°C). Staying within temperature range will provide optimum life expectancy of the battery pack.



This equipment is suitable for use in:

Class 1, Division 2, Groups A,B,C,D; Class II, Division 2, Groups F & G; Class III or non-hazardous locations only.
Maximum T-Code T6 55°C

In Conformity to European Norms
Ex nL IIC T3 II 3 G



WARNING: Explosion Hazard – substitution of any components may impair suitability for Class I, II & III, Division 2 locations.

WARNING: Explosion Hazard – batteries must only be changed in an area known to be non-hazardous.

CAUTION: The battery used in this device may present a fire or chemical burn hazard if mistreated. Do not recharge, disassemble, heat above 100° C (212° F) or dispose of in fire. Dispose of used battery promptly.

1. Time Selector Switch, Microprocessor based circuit board, Indicator Light
2. Replaceable Battery Pack
3. DC Motor
4. Replaceable Lubricant Reservoir (cartridge)
5. Retaining Ring
6. ½" NPT Mounting Outlet

**1 year
replacement warranty
on the drive unit**

**MUST USE ATS BATTERY
PACKS TO MAINTAIN
WARRANTY AND UL
LISTED STATUS**

Dimensions

(includes weathercap – not shown)

Jak 125: 7 ¼" high x 3 5/8" dia.

Jak 250: 9" high x 3 5/8" dia.

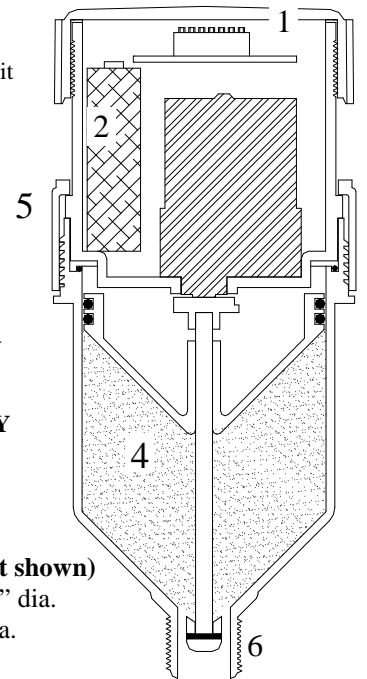

Starting Procedure

Referring to the proper model's dispensing rate chart on page 3 or 4, select the dispensing time and amount of lubricant required. Then set the appropriate switch or switches to the setting which corresponds to the period of time it takes to empty the unit. This action activates the unit, and within 1 minute the first cycle will commence dispensing.

Operating Procedure

If it is desired to increase or decrease the lubricant dispensing rate during operations, simply click the switch or switches in use to OFF, Then click on the new switch setting for the revised rate.

To turn **OFF** the **JACK-LUBER™** set all switches to **OFF**.

PURGE SETTING - Switch 7 is the purge switch. PRIOR to turning on Purge Switch 7, any of the other 6 switches **MUST** be turned on first. Once purge is completed, turn Switch 7 **OFF**. The **JACK-LUBER™** will run for approximately 2 minutes. After purge, set switch to desired dispensing rate. If you require more purging, repeat the procedure.

While the unit is operational, the LED light will flash green once every 20 seconds, indicating the electronics are functioning properly. During the pump cycle, the LED will flash green approximately once per second, indicating that the pump is turning and pumping grease. If there is a problem with the unit, it will be indicated by the Red or Blue LED flashing every 20 seconds as follows:

LED LIGHT FUNCTIONS:

LED	SIGNAL	SIGNAL TIME	MEANING
Green	1 Flash	Every 20 Seconds	Operation OK
Green	1 Flash	Every 1 Second	Currently pumping grease
Red	1 Flash	Every 20 Seconds	If Internal limit switch counter is faulty, the unit will go into an operational timed failsafe mode.
Red	2 Flashes	Every 20 Seconds	Low battery. Must be replaced shortly.
Blue	2 Flashes	Every 20 Seconds	Unit paused via remote control option (if used here)







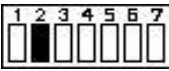
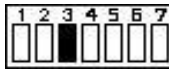
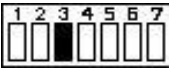
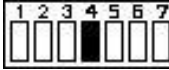

NOTE: The lubricants dispensed by this equipment are to have flash points greater than 200°F.

Power

The battery packs should be replaced every time a new grease cartridge is installed. Please note that battery life is affected by temperature, bearing backpressure and unit setting. Life expectancy is based on standard installation. To change the battery pack, remove the top ring, unplug and remove the old battery pack, and then install and plug in the new battery pack. Optional alternate power sources are available. Please consult the factory or your salesperson.

Comparison Chart

This chart compares the lubricant output rate of the **JACK-LUBER™** with several common manual lubrication schedules. The **JACK-LUBER™** switch settings indicated will provide comparable lubrication to that of the manual practice shown. **Do not over-lubricate bearing.** Some typical settings follow, see the charts on the next page for all settings.

Manual Lubrication Schedule	JACK Model 125		JACK Model 250	
	Unit Life	Switch Setting	Unit Life	Switch Setting
Daily lubrication 3 – 4 strokes	1 month (30 days)		2 months (60 days)	
2–3 day lubrication 3 – 4 strokes	2 months (60 days)		4 months (120 days)	
Weekly lubrication 8 – 10 strokes	3 months (90 days)		6 months (180 days)	
Bi-weekly lubrication 8 – 10 strokes	6 months (180 days)		12 months (360 days)	
Monthly lubrication 8 – 10 strokes	12 months (360 days)		24 months (720 days)	
Bi-monthly lubrication 8 – 10 strokes	24 months (720 days)			

A “Rule of Thumb” for Switch Setting

This chart offers a “Rule for Thumb” for selecting appropriate switch settings and lubricant output rate for some basic applications. Many variables must be considered when determining the best setting for your operating environment. Areas of high contamination and heavy water washout generally require a slight increase in lubricant flow rate. Because of the wide number of variables found in actual operating environments, this chart should only be considered as a guide in making the selection of the proper switch setting.

ALWAYS AVOID OVER-LUBRICATING.

Bearing Shaft Size	JACK 125		JACK 250	
	Days to Empty	Switch Setting	Days to Empty	Switch Setting
4 ¾” to 6 ½”	15		30	
4” to 4 ¾”	30		60	
3 ¼” to 4”	60		120	
2 ¾” to 3 ¼”	90		180	
2 ¼” to 2 ¾”	180		360	
1 ¾” to 2 ¼”	360		720	

Selection of Switch Settings

One stroke from a typical grease gun is equal to approximately one cubic centimetre (cc). To select the switch setting appropriate for your application look down the column for the desired output of lubricant, remembering that 1 cc is equal to approximately one stroke from a grease gun. The switch setting for your selection is shown in the right most columns labelled Switch1 to Switch7.

Jack-Luber™ 125 cc Dispensing Rate Chart

Days to Empty	Cycle Time (hrs)	Approx. Daily Output		Switch 1 (15 day)	Switch 2 (30 day)	Switch 3 (60 day)	Switch 4 (120 day)	Switch 5 (240 day)	Switch 6 (480 day)	Switch 7 (purge)
		in CC's	in CI's							
15	1.4	8.37	0.51	ON	OFF	OFF	OFF	OFF	OFF	OFF
30	2.9	4.19	0.26	OFF	ON	OFF	OFF	OFF	OFF	OFF
45	4.3	2.79	0.17	ON	ON	OFF	OFF	OFF	OFF	OFF
60	5.7	2.09	0.13	OFF	OFF	ON	OFF	OFF	OFF	OFF
90	8.6	1.40	0.09	OFF	ON	ON	OFF	OFF	OFF	OFF
120	11.5	1.05	0.06	OFF	OFF	OFF	ON	OFF	OFF	OFF
150	14.3	0.84	0.05	OFF	ON	OFF	ON	OFF	OFF	OFF
180	17.2	0.70	0.04	OFF	OFF	ON	ON	OFF	OFF	OFF
240	22.9	0.52	0.03	OFF	OFF	OFF	OFF	ON	OFF	OFF
300	28.7	0.42	0.03	OFF	OFF	ON	OFF	ON	OFF	OFF
360	34.4	0.35	0.02	OFF	OFF	OFF	ON	ON	OFF	OFF
480	45.8	0.26	0.02	OFF	OFF	OFF	OFF	OFF	ON	OFF
600	57.4	0.21	0.01	OFF	OFF	OFF	ON	OFF	ON	OFF
720	68.8	0.17	0.01	OFF	OFF	OFF	OFF	ON	ON	OFF

Jack-Luber™ 250 cc Dispensing Rate Chart

	Cycle Time (hrs)	Approx. Daily Output		Switch 1 (15 day)	Switch 2 (30 day)	Switch 3 (60 day)	Switch 4 (120 day)	Switch 5 (240 day)	Switch 6 (480 day)	Switch 7 (purge)
		in CC's	in CI's							
15	.7	16.74	1.02	ON	OFF	OFF	OFF	OFF	OFF	OFF
30	1.5	8.37	0.51	OFF	ON	OFF	OFF	OFF	OFF	OFF
45	2.2	4.19	0.26	ON	ON	OFF	OFF	OFF	OFF	OFF
60	2.9	2.79	0.17	OFF	OFF	ON	OFF	OFF	OFF	OFF
90	4.3	2.09	0.13	OFF	ON	ON	OFF	OFF	OFF	OFF
120	5.8	1.40	0.09	OFF	OFF	OFF	ON	OFF	OFF	OFF
150	7.2	1.05	0.06	OFF	ON	OFF	ON	OFF	OFF	OFF
180	8.6	0.84	0.05	OFF	OFF	ON	ON	OFF	OFF	OFF
240	11.5	0.70	0.04	OFF	OFF	OFF	OFF	ON	OFF	OFF
300	14.4	0.52	0.03	OFF	OFF	ON	OFF	ON	OFF	OFF
360	17.2	0.42	0.03	OFF	OFF	OFF	ON	ON	OFF	OFF
480	22.9	0.35	0.02	OFF	OFF	OFF	OFF	OFF	ON	OFF
600	28.8	0.26	0.02	OFF	OFF	OFF	ON	OFF	ON	OFF
720	34.4	0.21	0.01	OFF	OFF	OFF	OFF	ON	ON	OFF

Jack-Luber™ Cartridge Replacement

1. Remove the Jack-Luber™ unit from the bearing.
2. Remove the retaining ring.
3. Separate the cartridge from the drive assembly.
4. Attach the new cartridge, making sure that the o-ring is installed. Line up the motor drive with the jackscrew, then join the units together, making sure that the notches on the drive unit and seat into keyways on the cartridge.
5. Tighten the retaining ring.
6. Replace the battery pack by removing the top cover, unplugging the pack, installing the new pack and connecting it to the circuit board assembly.
7. Confirm your DIP switch setting with the dispensing rate chart and then replace the top cover.

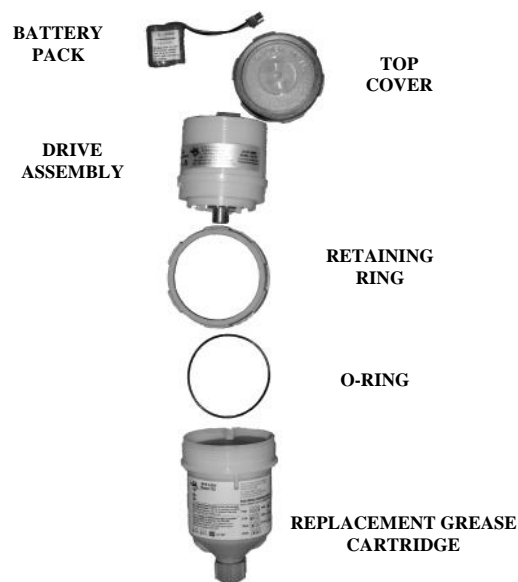

For other settings or special applications, please consult the factory or check our website for your nearest Distributor

PATENT: US#9151443 B2



For more information, please visit our website at www.atselectrolube.com

Sala Industrial Sales Corp.
PO Box 111
Mechanicsville, VA 23111

www.salaindustrialsales.com

Distributed by Sala Industrial Sales Corp.
Phone: 804-779-2474 Fax: 804-781-6329
Email: salaindustrialsales@gmail.com

BS EN ISO 9001:2008
FM 66860

Not responsible for damage or consequential damage beyond replacement or refund of amount paid.
En cas de dommage, la responsabilité d'A.T.S. se limite au remplacement ou au remboursement de l'appareil